

NOTES:

1. RATED COOLING: 1320 WATTS AT 20DEG C ΔT (66WATTS/DEG C, MOUNTED TO AN UNINSULATED 72x36x24" ENCLOSURE).
2. DESIGNED FOR SURFACE MOUNTING ON INSIDE OF ENCLOSURE.
3. ANODIZED ALUM OR POWDER COATED HOUSING.
4. EQUIPPED WITH MOUNTING GASKET FOR AIR TIGHT SEAL.
5. INLET AIR FILTER OPTIONAL.
- *6. ASTERISK INDICATES EXTRA MOUNTING HOLES FOR "P" UNIT WHICH IS PRESSURE TESTED TO INSURE LIQUID TIGHT SEAL. UNIT HAS FOUR MATCHING 8-32-2B(FEMALE) THREADED FASTENERS.

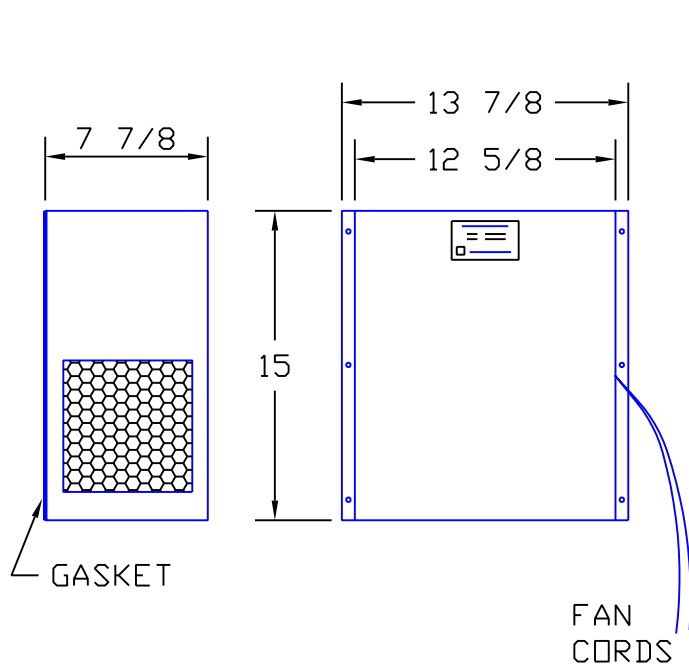

DIMENSIONS

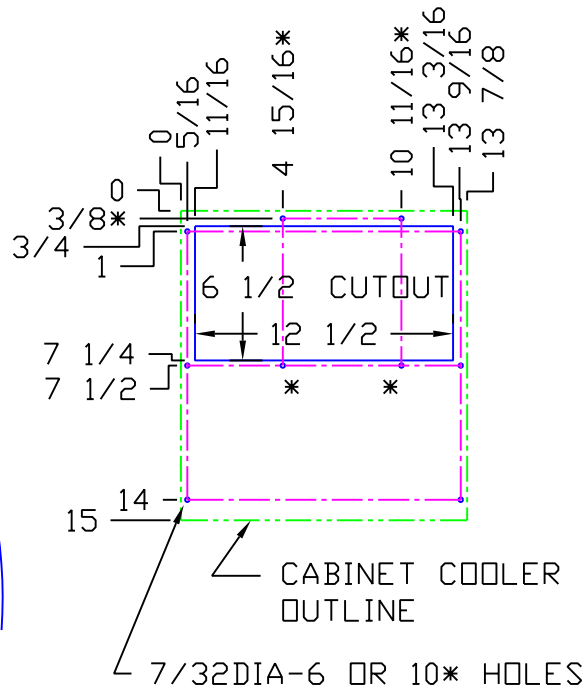

ENCLOSURE HOLE PATTERN

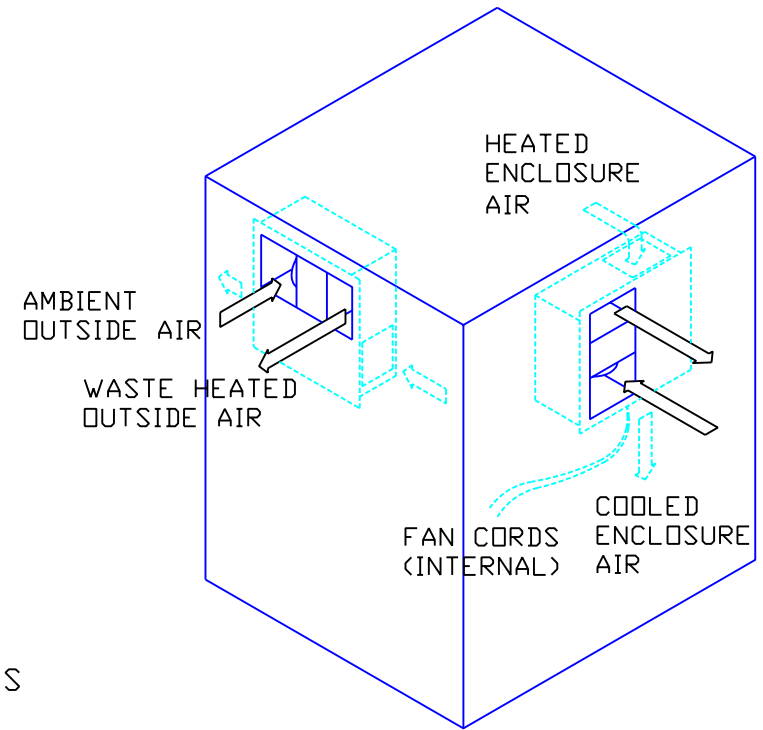

CC900I & CC900IP*

BY:EM 12/15/00	NOREN PRODUCTS, INC. 1010 O'BRIEN DR. MENLO PARK, CA. 94025 (650)322-9500 www.NorenProducts.com
CK:DL 12/11/00	
AP:DN 12/15/00	ALL DIMENSIONS ARE IN INCHES.
A883207	